



AUTOMATIC SCORING

BOWLER CONSOLES

Pre Installation Manual

 4600 Arrow Hwy.
Montclair, California 91763 USA

 Service@SteltronicUSA.com

 (909) 971-9656

 SteltronicUSA.com

Contents

STELTRONIC BOWLER CONSOLE PRE-INSTALLATION

- Bowler Console Configurations 1
- Bowler Console Baseplate Footprints 2
- Bowler Console Power Requirements..... 3
- Bowling Ball Storage and Table 4

STELTRONIC BOWLER CONSOLE PRE-INSTALLATION

BOWLER CONSOLE CONFIGURATIONS

Steltronic offers a variety of bowler console styles, each with its unique features. Depending on the specific console you have chosen, certain considerations must be taken care of before the installation team arrives.

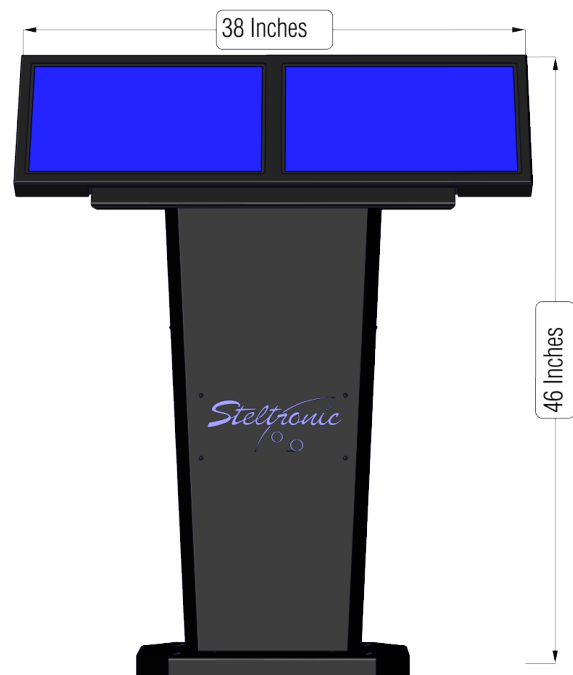
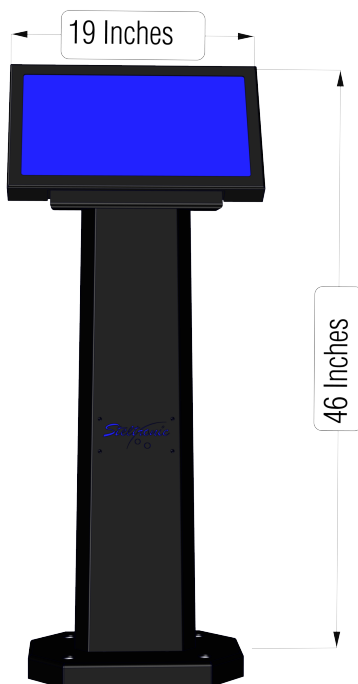

BOWLER CONSOLE BASEPLATE FOOTPRINTS

The following diagrams depict the precise dimensions of the bowler console baseplates that will be affixed to your concrete or wooden floor. The Steltronic bowler consoles, whether Keypads or Touch Screens, will be installed behind your ball return system.

The dimensions provided below specifically refer to the base plate dimensions of the bowler console pedestals.

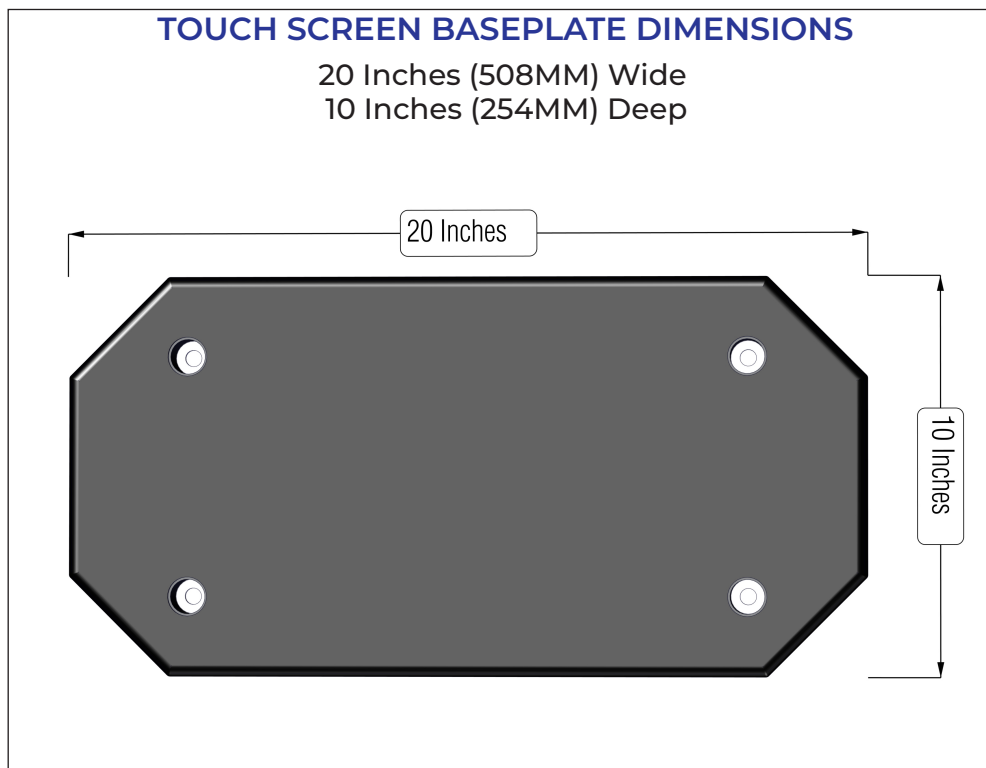
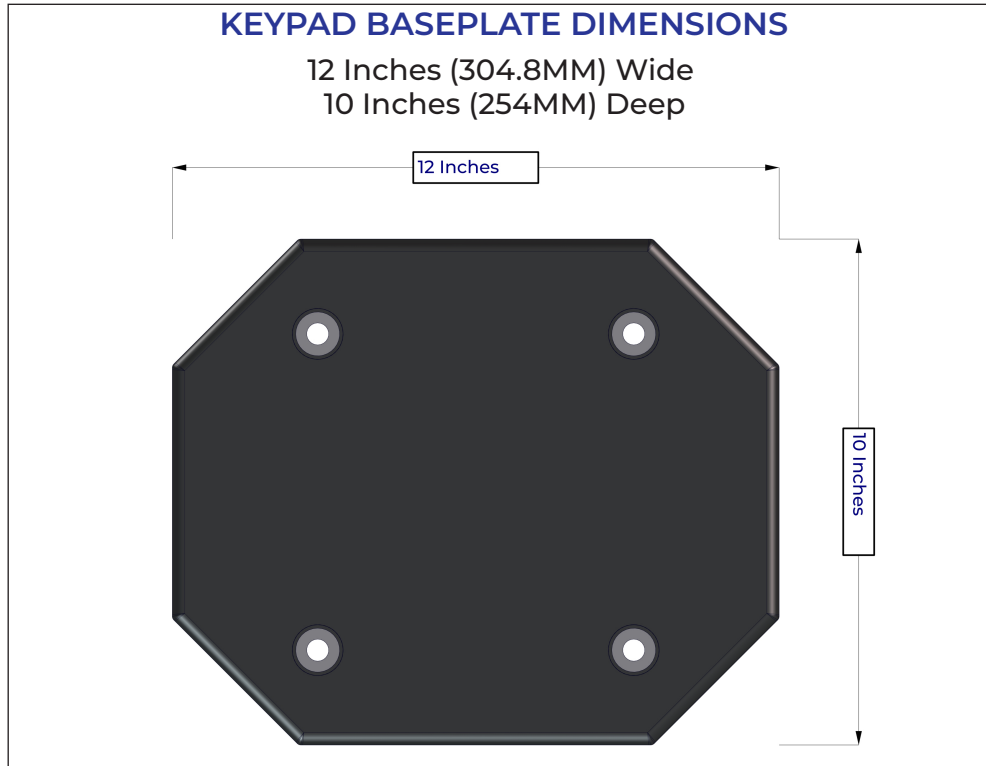

BOWLER CONSOLE POWER REQUIREMENTS

Within the diagrams below, note that the bowler consoles are slated for installation behind the synthetic or wood approach used by bowlers. The flooring in the bowling center is typically composed of concrete or wood, and to facilitate the necessary connectivity, the bowler console requires a conduit for the cables, allowing seamless access from the console to the underground ball return system.

1. Keypad bowler console installations:

- I. A conduit or access will be necessary to allow the cables to run from your keypads to the underground ball return system all the way to the pinsetters.

2. Touch Screen console installations:

- I. Ensure access to high voltage power is available for the lower monitor touch screens.
- II. Set up a separate conduit for low voltage and video cables.

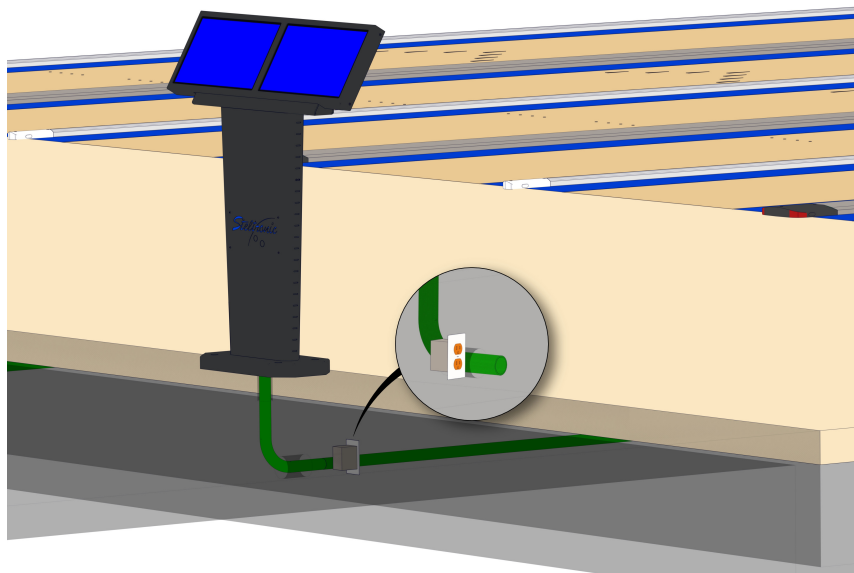
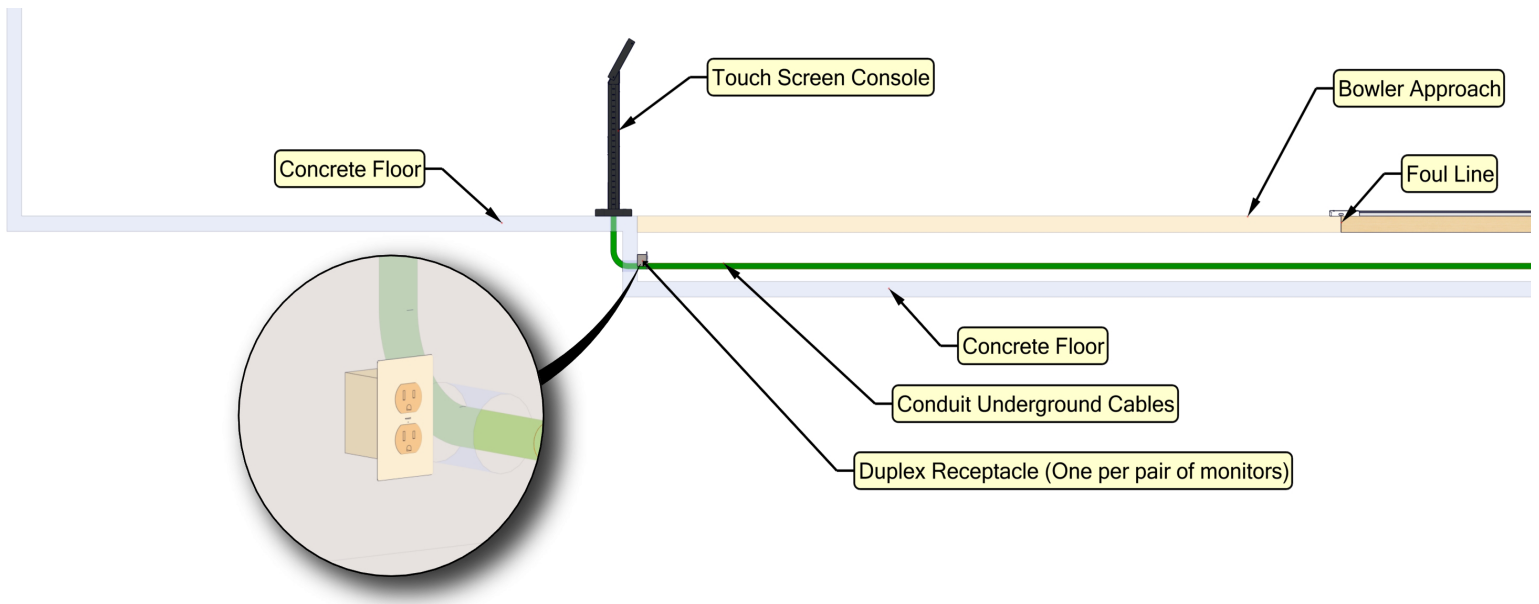

BOWLING BALL STORAGE AND TABLE

Additionally, Steltronic provides a bowling ball storage rack in conjunction with a cocktail table. The ball storage rack has the capacity to accommodate up to twelve (12) bowling balls. In cases where the bowler console keypad is positioned atop the table, there is a designed access point from the table's surface to the base of the bowling ball storage. It is crucial to exercise care in routing the cabling to ensure proper access to the underground ball return system, allowing installers to implement the necessary cabling for seamless and effective operation.

BOWLING BALL STORAGE DIMENSIONS

- 24 Inches (609.6MM) Wide
- 45 Inches (1,143MM) Tall (With Keypad)
- 40 Inches (1,016MM) Tall (No Keypad)

